

RETAINING "CINCH" PLATE

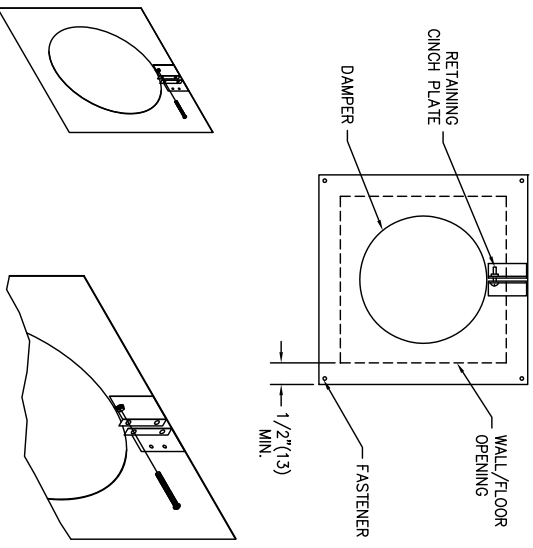

DO NOT PLACE PLATES IN GROOVE

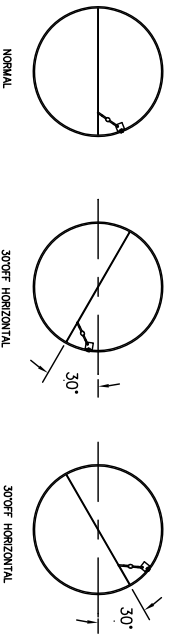
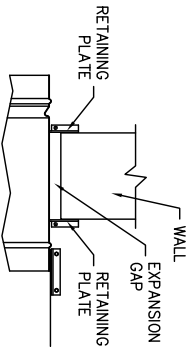

GENERAL INSTALLATION

IN 1 AND 2 HR RATED MASONRY FLOORS AND CEILINGS OR WALLS

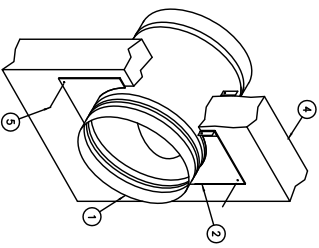

FIGURE 2

- ITEM DESCRIPTION
1. F0R25 ROUND FIRE DAMPER
 2. RETAINING PLATE, 20 GA. STEEL
 3. DUCT
 4. MASONRY WALL CONSTRUCTION
 5. #10 CONCRETE ANCHOR
 6. DRAW BAND

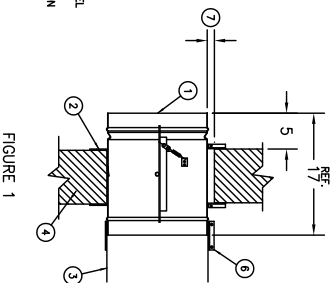

FIGURE 1

WITHIN SQUARE OPENING IN METAL OR WOOD STUD FRAMING IN 1 AND 2 HR RATED DRYWALL PARTITIONS

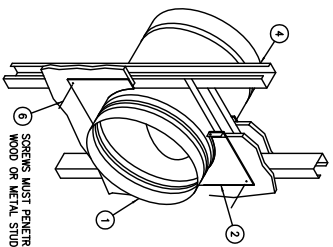

FIGURE 4

- ITEM DESCRIPTION
1. F0R25 ROUND FIRE DAMPER
 2. RETAINING PLATE, 20 GA. STEEL
 3. DUCT
 4. METAL STUD WALL CONSTRUCTION
 5. WOOD STUD WALL CONSTRUCTION
 6. #10 STEEL METAL SCREW
 7. DRAW BAND

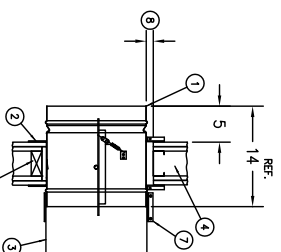

FIGURE 3